 NORTHERN MECHATRONICS INC. CONFIDENTIAL ALL RIGHTS RESERVED	
DRAWN BY Lucia Iannantuono	PROGRAM Petal Core (NM180400)
R&D CHECK Joshua Wong	TITLE Petal Core Block Diagram
MFG CHECK Joshua Wong	DRAWING NUMBER SCH-2002965-005
EDITED BY Lucia Iannantuono	REVISION B
LAST EDIT Wednesday, December 04, 2024	SIZE B
SHEET 1	of 12

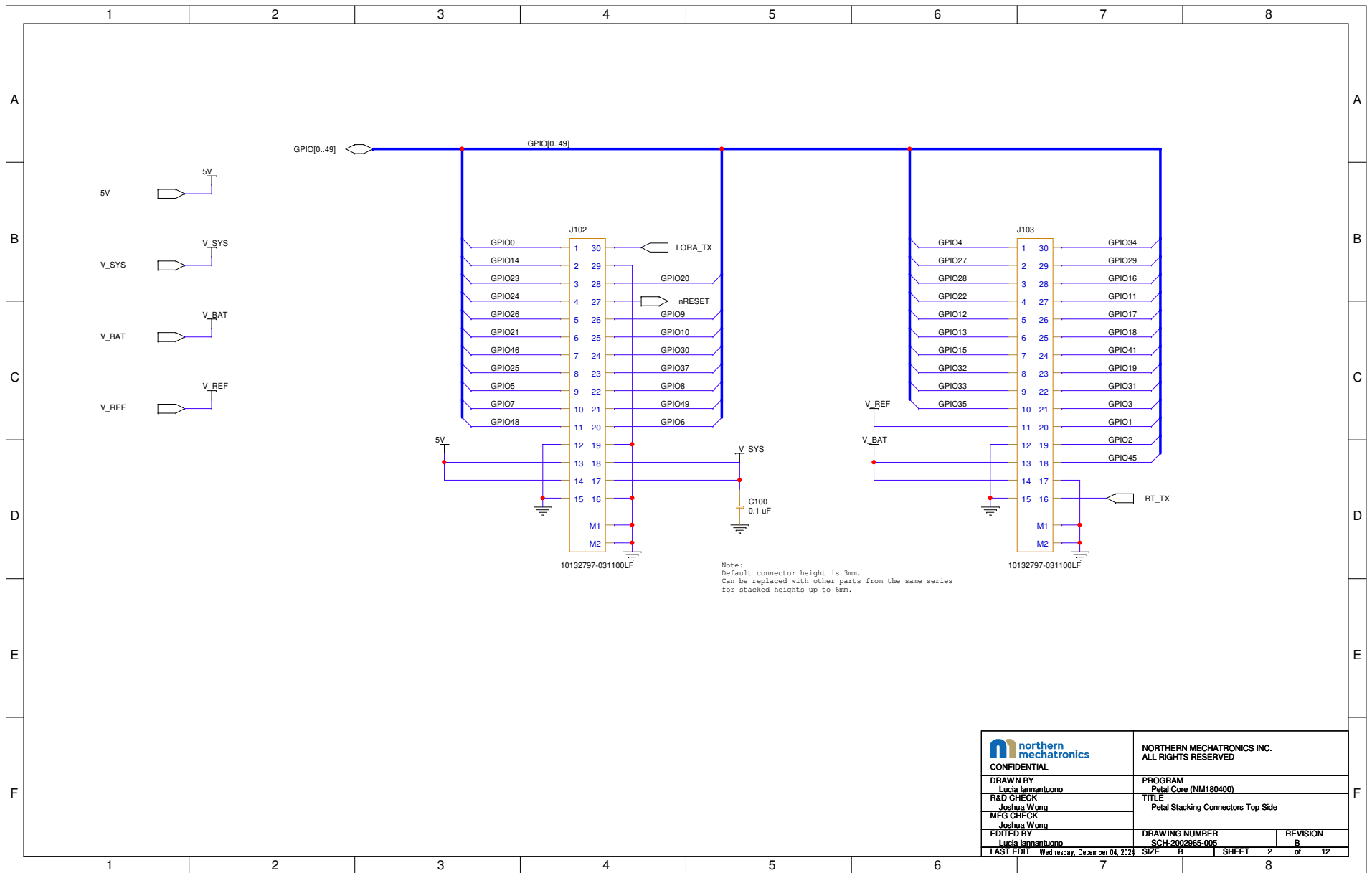

northern mechatronics CONFIDENTIAL		NORTHERN MECHATRONICS INC. ALL RIGHTS RESERVED	
DRAWN BY Lucia Iannantuono		PROGRAM Petal Core (NM180400)	
R&D CHECK Joshua Wong		TITLE Petal Stacking Connectors Top Side	
MFG CHECK Joshua Wong		DRAWING NUMBER SCH-2002965-005	
EDITED BY Lucia Iannantuono		REVISION B	
LAST EDIT Wednesday, December 04, 2024		SIZE B	SHEET 2 of 12

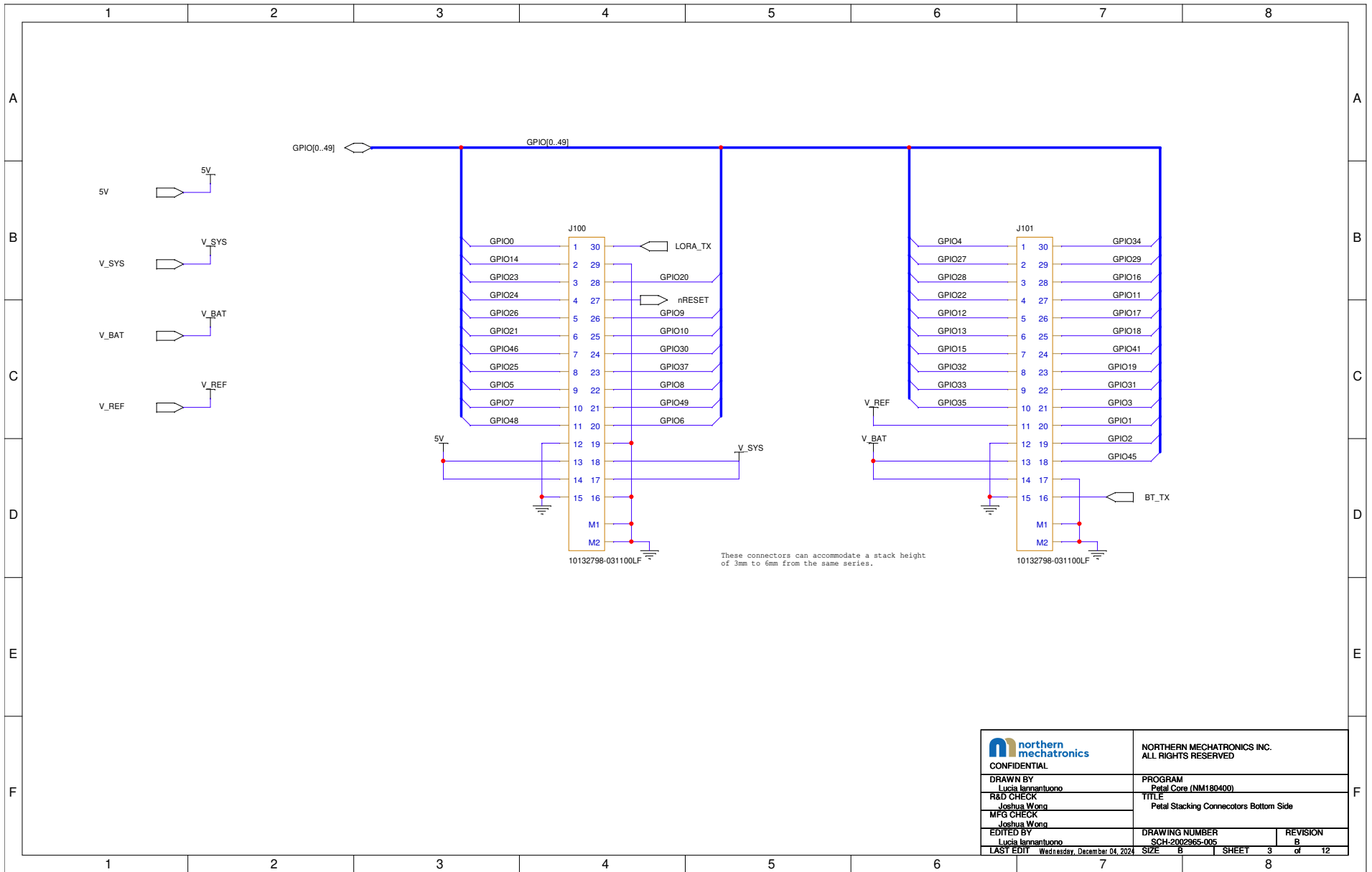

		NORTHERN MECHATRONICS INC. ALL RIGHTS RESERVED	
CONFIDENTIAL		PROGRAM Petal Core (NM180400)	
DRAWN BY Lucia Iannantuono		TITLE Petal Stacking Connectors Bottom Side	
R&D CHECK Joshua Wong			
MFG CHECK Joshua Wong			
EDITED BY Lucia Iannantuono		DRAWING NUMBER SCH-2002965-005	REVISION B
LAST EDIT Wednesday, December 04, 2024		SIZE B	SHEET 3 of 12

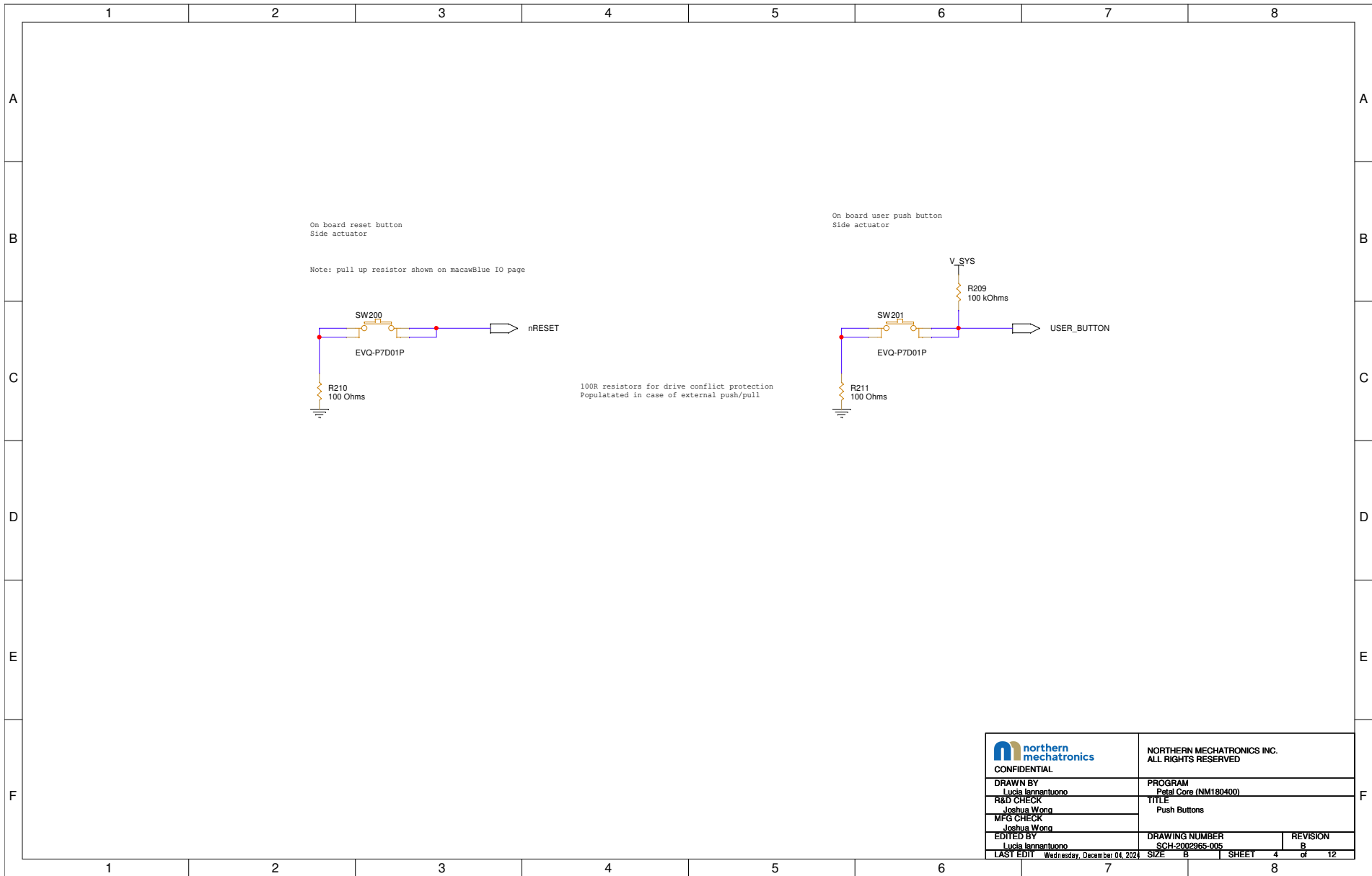

 NORTHERN MECHATRONICS INC. CONFIDENTIAL ALL RIGHTS RESERVED	
DRAWN BY Lucia Iannantuono	PROGRAM Petal Core (NM180400)
R&D CHECK Joshua Wong	TITLE Push Buttons
MFG CHECK Joshua Wong	DRAWING NUMBER SCH-2002965-005
EDITED BY Lucia Iannantuono	REVISION B
LAST EDIT Wednesday, December 04, 2024	SIZE B
SHEET 4	of 12

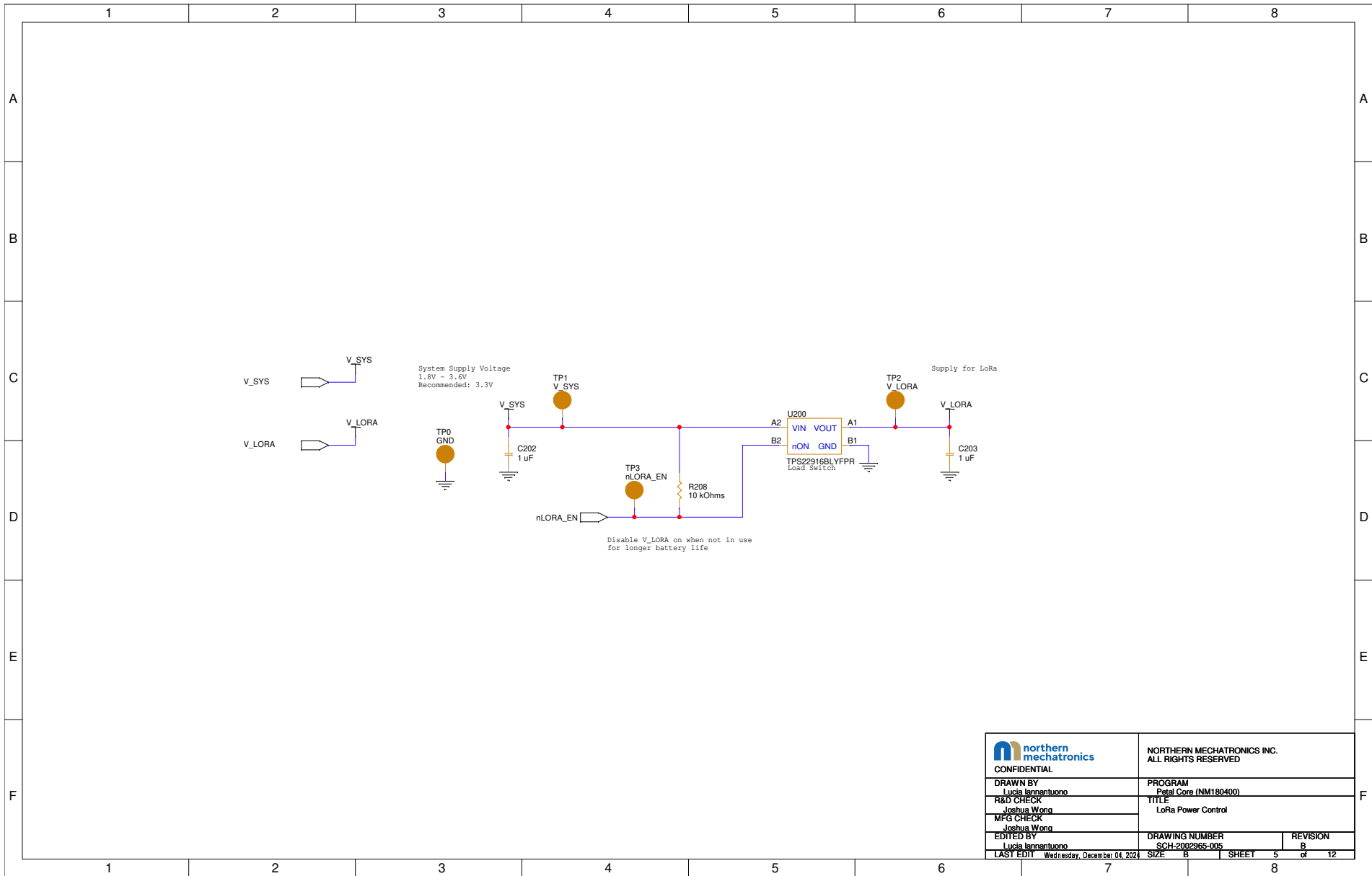

 NORTHERN MECHATRONICS INC. ALL RIGHTS RESERVED	
CONFIDENTIAL	
DRAWN BY Lucia Iannantuono	PROGRAM Petal Core (NM180400)
R&D CHECK Joshua Wong	TITLE LoRa Power Control
MFG CHECK Joshua Wong	
EDITED BY Lucia Iannantuono	DRAWING NUMBER SCH-2002965-005
LAST EDIT Wednesday, December 04, 2024	REVISION B
SIZE B	SHEET 5 of 12

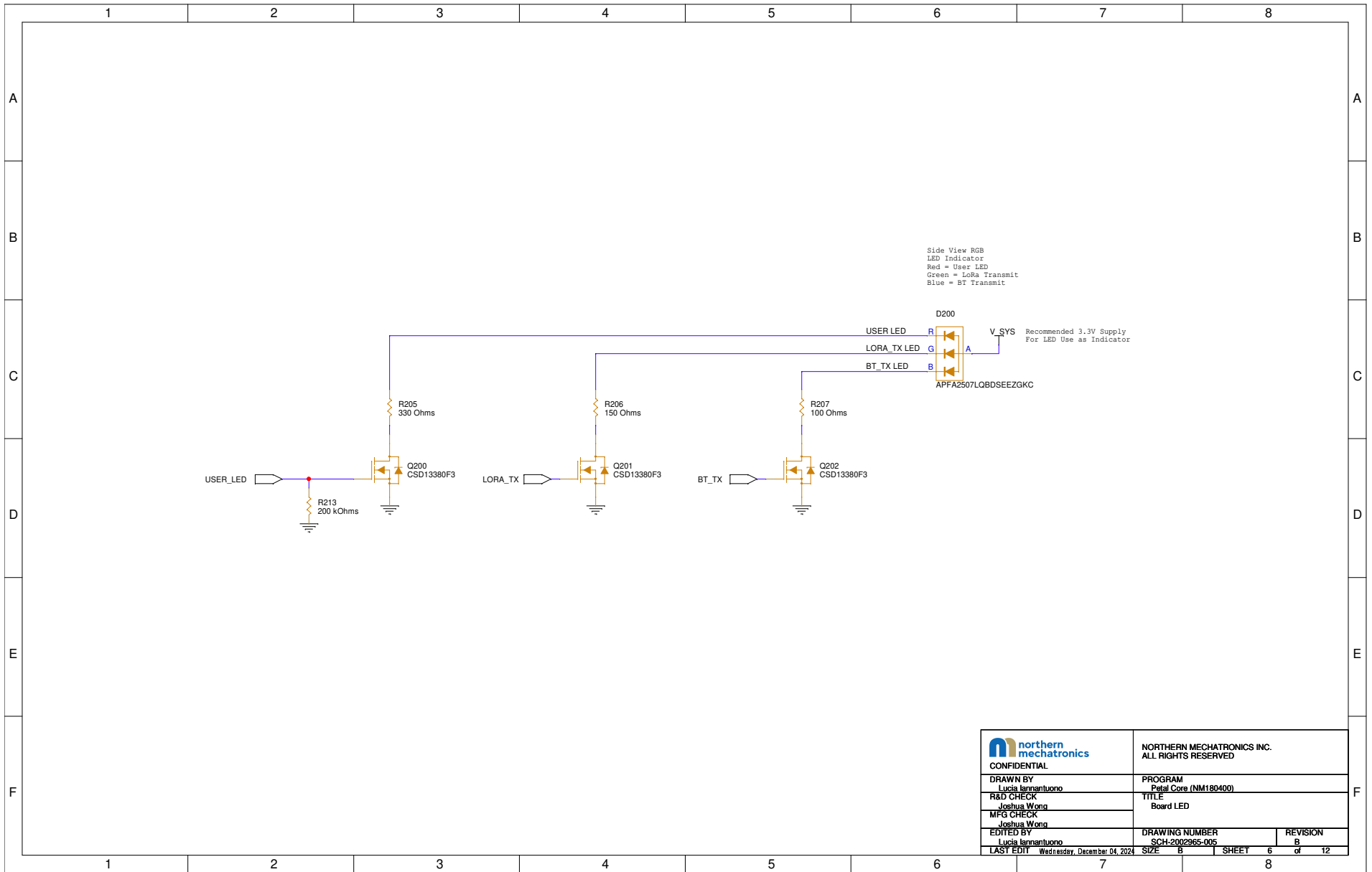

 northern mechatronics CONFIDENTIAL	NORTHERN MECHATRONICS INC. ALL RIGHTS RESERVED	
	DRAWN BY Lucia Iannantuono	PROGRAM Petal Core (NM180400)
R&D CHECK Joshua Wong	TITLE Board LED	
MFG CHECK Joshua Wong		
EDITED BY Lucia Iannantuono	DRAWING NUMBER SCH-2002965-005	REVISION B
LAST EDIT Wednesday, December 04, 2024	SIZE B	SHEET 6 of 12

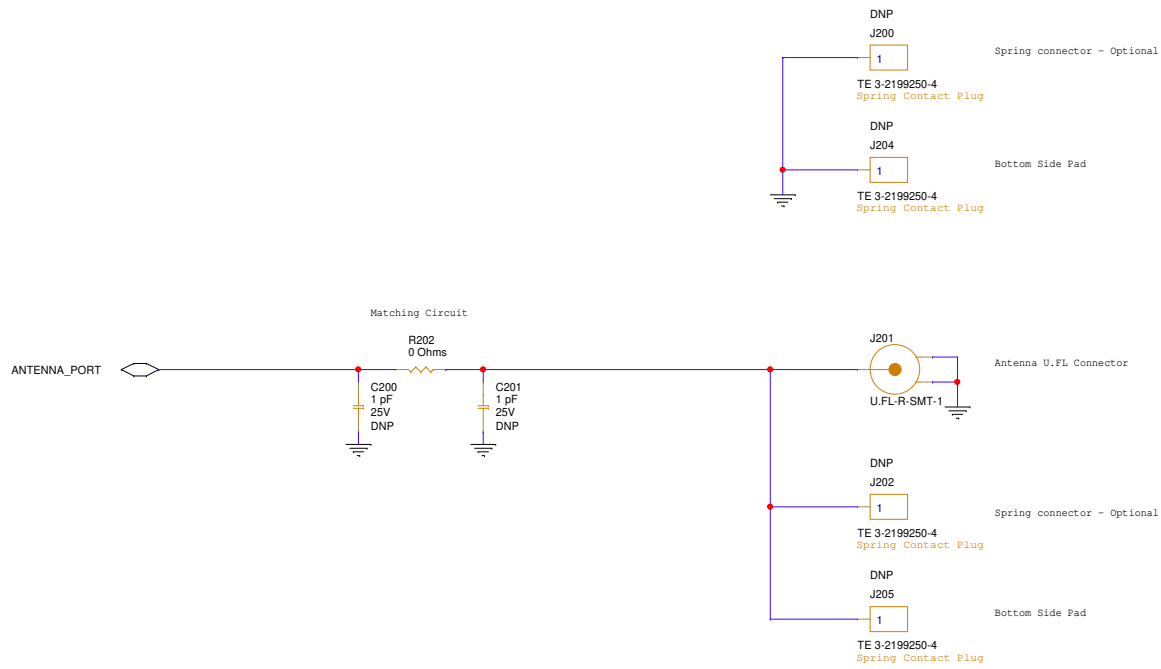

 NORTHERN MECHATRONICS INC. CONFIDENTIAL ALL RIGHTS RESERVED	
DRAWN BY Lucia Iannantuono	PROGRAM Petal Core (NM180400)
R&D CHECK Joshua Wong	TITLE Antenna Block
MFG CHECK Joshua Wong	
EDITED BY Lucia Iannantuono	DRAWING NUMBER SCH-2002965-005
LAST EDIT Wednesday, December 04, 2024	REVISION B
SIZE B	SHEET 7 of 12

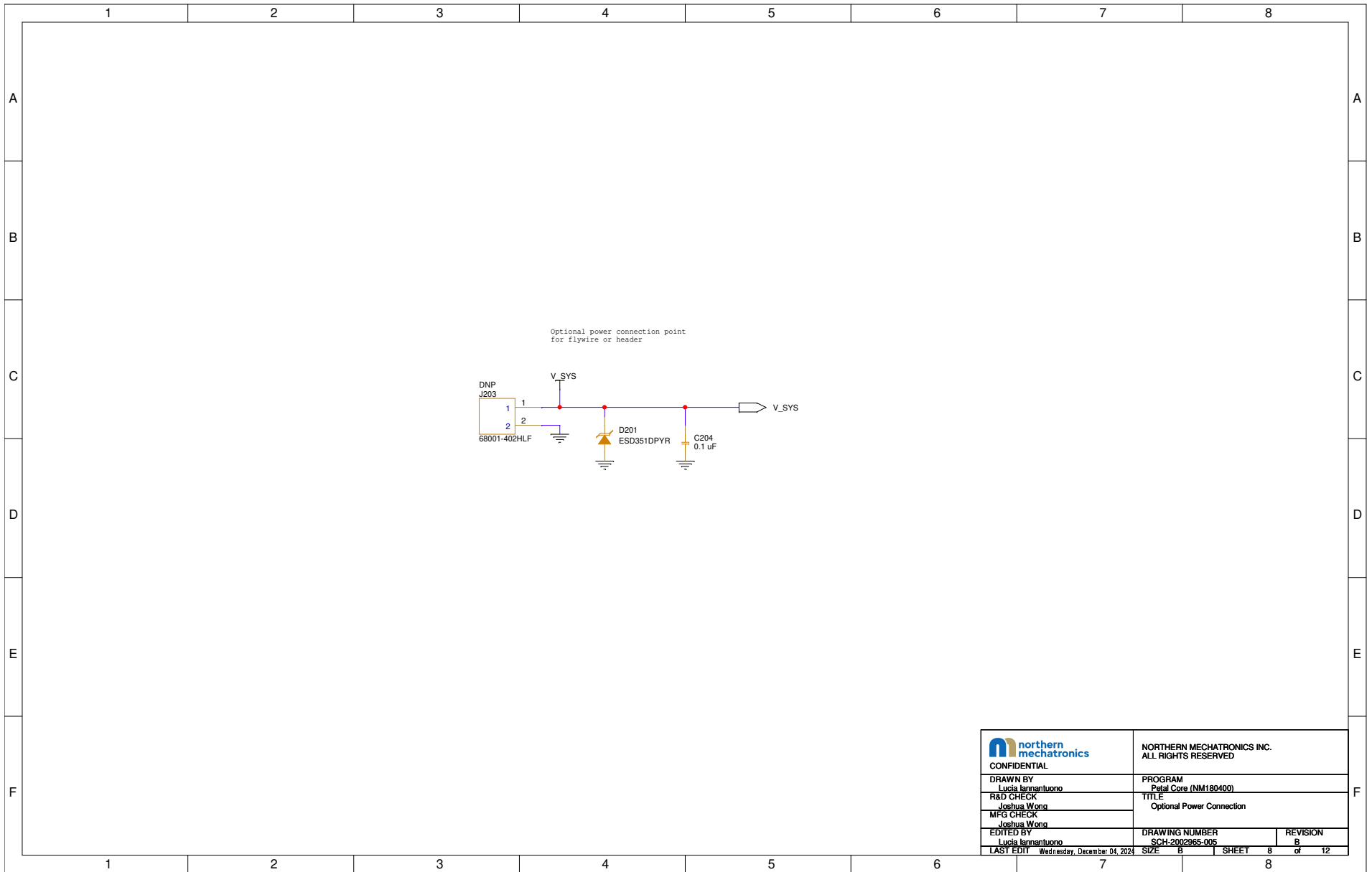

 NORTHERN MECHATRONICS INC. ALL RIGHTS RESERVED	
CONFIDENTIAL	
DRAWN BY Lucia Iannantuono	PROGRAM Petal Core (NM180400)
R&D CHECK Joshua Wong	TITLE Optional Power Connection
MFG CHECK Joshua Wong	
EDITED BY Lucia Iannantuono	DRAWING NUMBER SCH-2002965-005
LAST EDIT Wednesday, December 04, 2024	REVISION B
SIZE B	SHEET 8 of 12

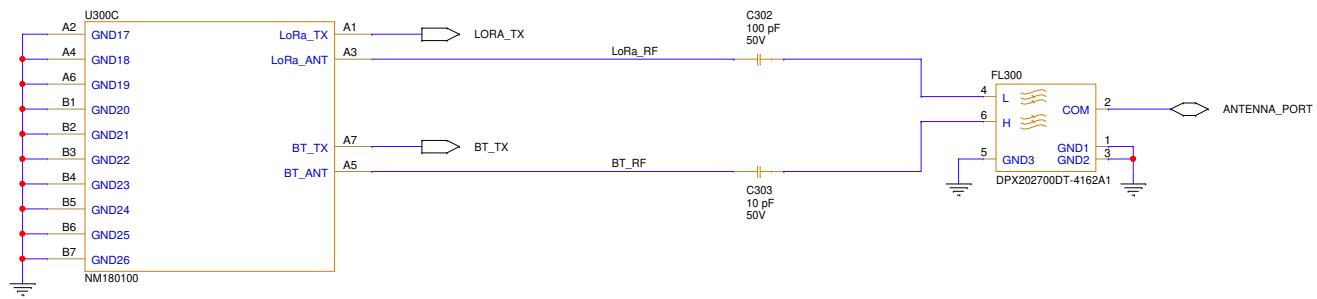

 NORTHERN MECHATRONICS INC. CONFIDENTIAL ALL RIGHTS RESERVED	
DRAWN BY Lucia Iannantuono	PROGRAM Petal Core (NM180400)
R&D CHECK Joshua Wong	TITLE NM180100 RF
MFG CHECK Joshua Wong	DRAWING NUMBER SCH-2002965-005
EDITED BY Lucia Iannantuono	REVISION B
LAST EDIT Wednesday, December 04, 2024	SIZE B
SHEET 9	of 12

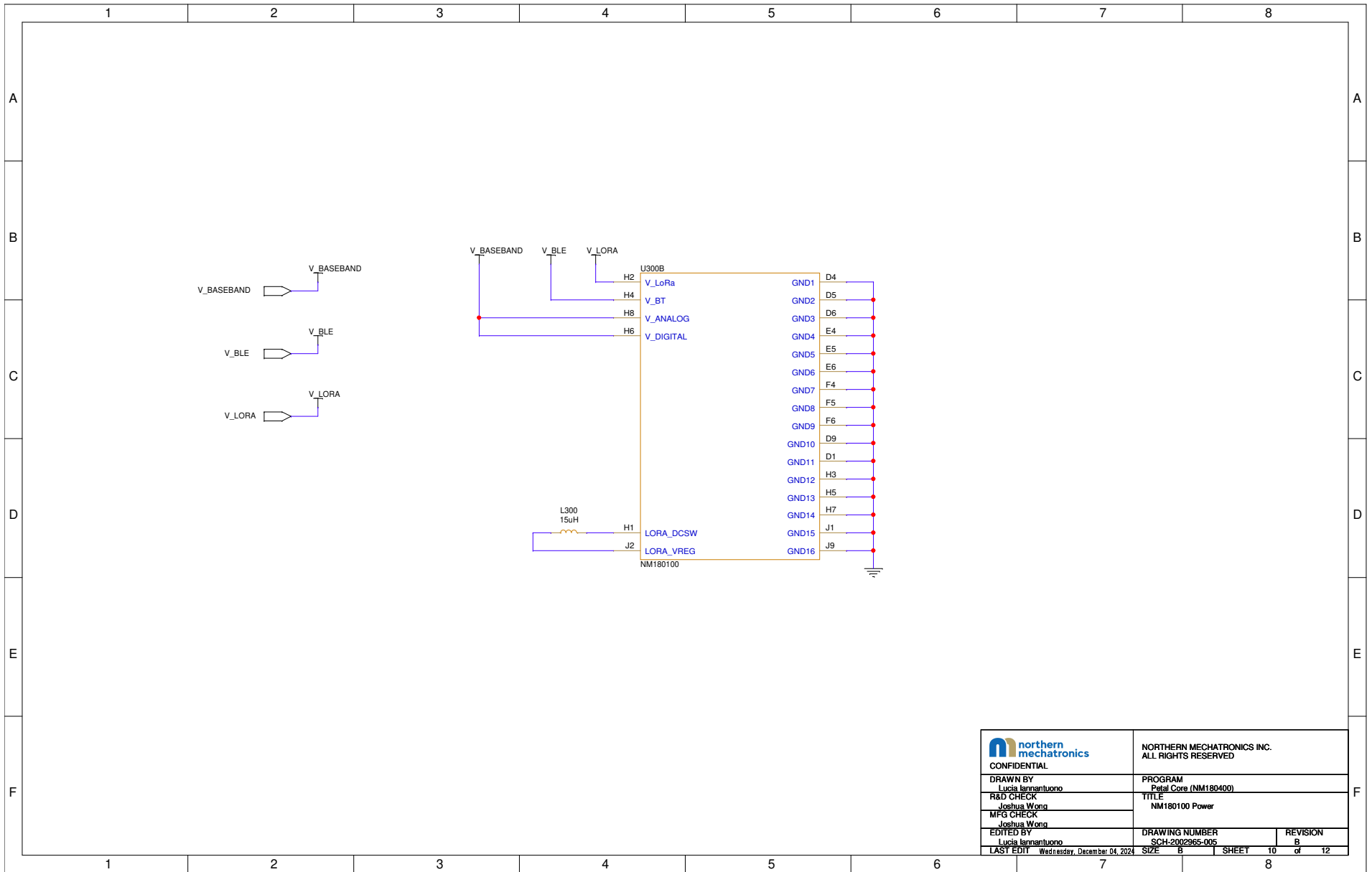

 northern mechatronics CONFIDENTIAL		NORTHERN MECHATRONICS INC. ALL RIGHTS RESERVED	
DRAWN BY Lucia Iannantuono		PROGRAM Petal Core (NM180400)	
R&D CHECK Joshua Wong		TITLE NM180100 Power	
MFG CHECK Joshua Wong		REVISION B	
EDITED BY Lucia Iannantuono		DRAWING NUMBER SCH-2002965-005	
LAST EDIT Wednesday, December 04, 2024		SIZE B	SHEET 10 of 12

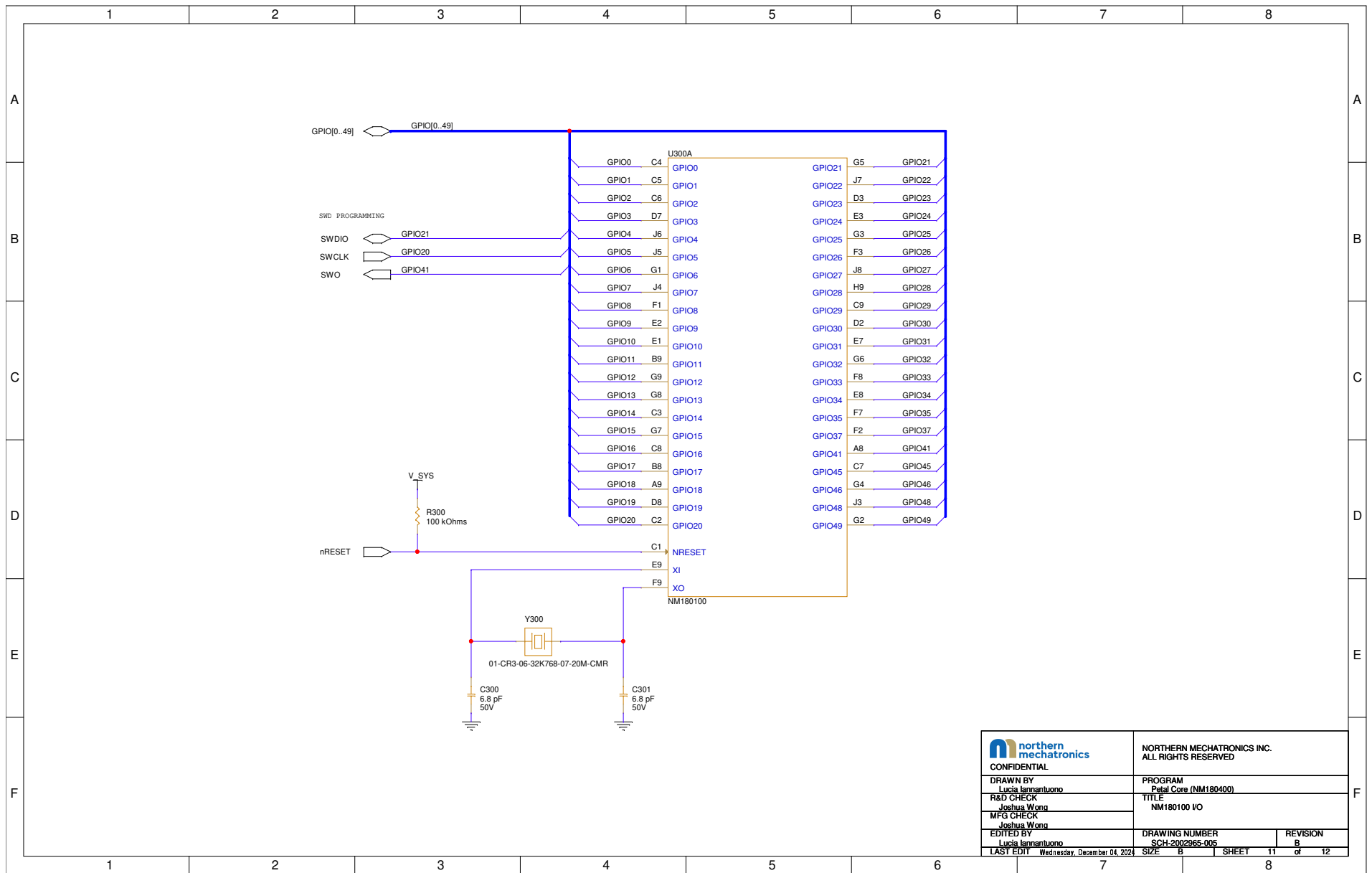

northern mechatronics CONFIDENTIAL		NORTHERN MECHATRONICS INC. ALL RIGHTS RESERVED	
DRAWN BY Lucia Iannantuono		PROGRAM Petal Core (NM180400)	
R&D CHECK Joshua Wong		TITLE NM180100 I/O	
MFG CHECK Joshua Wong			
EDITED BY Lucia Iannantuono		DRAWING NUMBER SCH-2002965-005	REVISION B
LAST EDIT Wednesday, December 04, 2024		SIZE B	SHEET 11 of 12

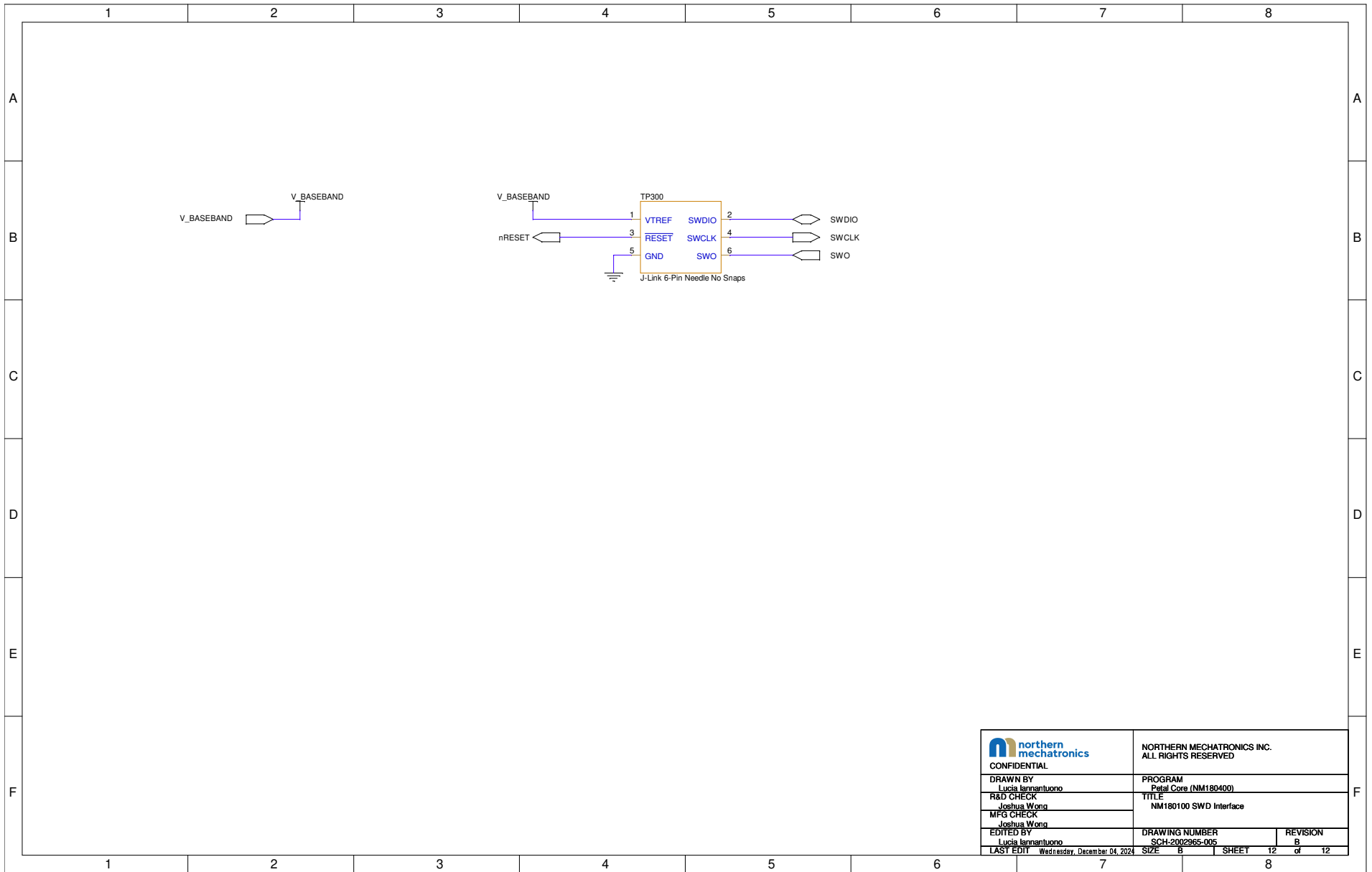

 NORTHERN MECHATRONICS INC. ALL RIGHTS RESERVED	
CONFIDENTIAL	
DRAWN BY Lucia Iannantuono	PROGRAM Petal Core (NM180400)
R&D CHECK Joshua Wong	TITLE NM180100 SWD Interface
MFG CHECK Joshua Wong	
EDITED BY Lucia Iannantuono	DRAWING NUMBER SCH-2002965-005
LAST EDIT Wednesday, December 04, 2024	REVISION B
SIZE B	SHEET 12 of 12